

NOVA Series

NOVA 15-50-B6 P30 WK

Inrunner BLDC motor with closed housing



Overview

The NOVA 15 Water-Cooled ("WK") is from our family of super rugged inrunner BLDC motors and has been designed for a wide range of mission critical applications.

Features

- Super robust housing for applications in the harshest environments
- Wear-free position and temperature sensors included in standard

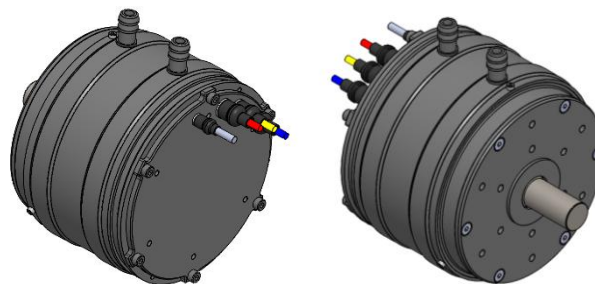

Specifications

Part number	02-044.050.01-000-351	
Peak output power	15	kW
Peak torque (max. 5s) ⁽¹⁾	40	Nm
Max. speed	8,000	rpm
Voltage range	30-120	V
Speed constant (kV)	65	rpm/V
Diameter (ex. water inlet)	131	mm
Length	97	mm
Weight	3,200	g
Phase cable length	100	mm
Sensor cable length	400	mm
Recommended phase cable extension	8	mm ² 8 AWG
Protection class	IP54	
Mounting	Front & back	
Direction of rotation	Both	
Cooling	Water cooled	
Ambient temperature range	-20 to +60 °C	
Max. temperature of stator (as measured by sensor)	+100	°C
Position sensor types	Hall effect sensor with UVW-commutation signals	
Temperature sensor	NTC 47 kΩ	
Number of poles	30	
Number of windings	6	
Phase resistance ⁽²⁾	25	mΩ
Phase inductance ⁽²⁾	41	μH
Recommendations for water cooling	Flow of 7 liters-per-minute at max. 40°C inlet temp.; coolant pressure shall not exceed 2 bar/ 29 PSI.	

Complementary Products

- Plettenberg gold connectors: GC6-00 / GC6-90

Heatmap

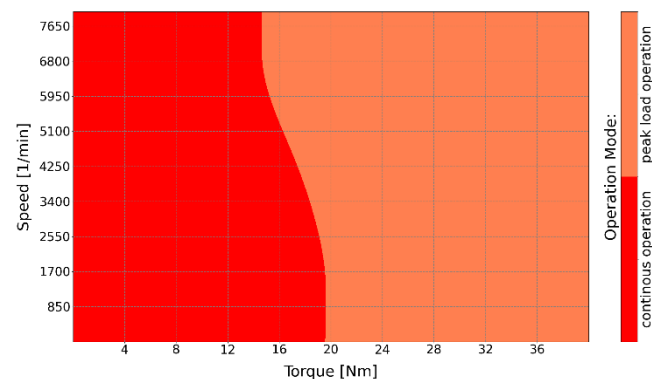

Note: Assuming water temperature of 40°C and 7 l/min flow.

Options & Customization

- Custom winding/kV versions
- MIL-STD 810H test reports
- MTBF/S report
- IP67 protection class
- Aerospace or MIL-DTL-38999 connectors
- Mechanical customization
- High RPM versions
- RTCA DO160 qualification

Notes:

⁽¹⁾ Peak torque with sensor-guided ESC. If using sensorless ESC, peak torque may be 10-20% lower.

⁽²⁾ Phase-to-phase value

Plettenberg Elektromotoren GmbH & Co. KG
Rostocker Straße 30
34225 Baunatal, Germany
T: +49 (0) 56 01 97 96-0
www.plettenbergmotors.com / sales@plettenbergmotors.com
© 2026 Plettenberg Elektromotoren GmbH & Co. KG. All rights reserved.



NOVA 15-50-B6 P30 WK

Inrunner BLDC motor with closed housing

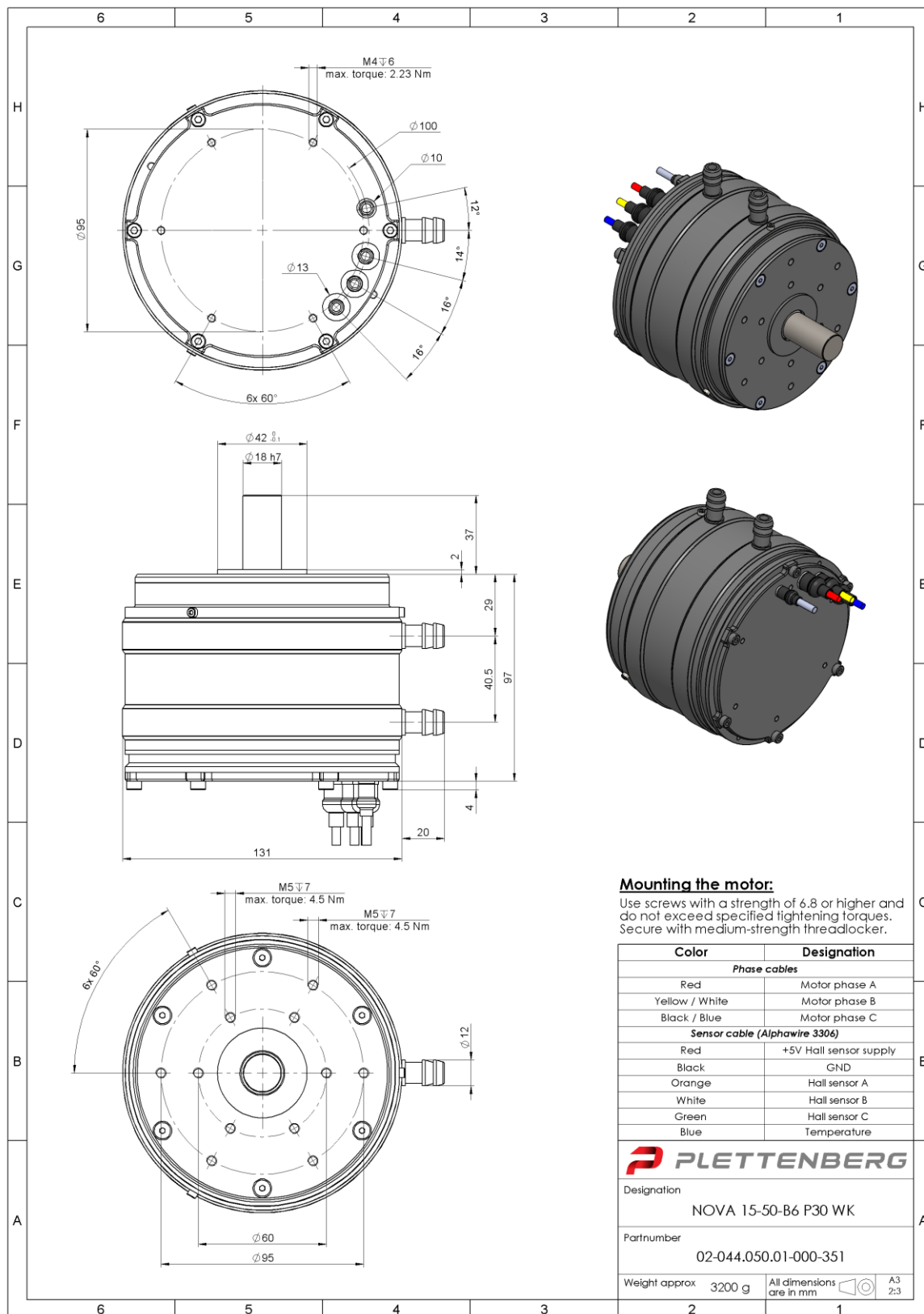

We reserve all rights for this drawing, also in case of patent grant or utility model registration. Without our prior consent, this drawing may neither be reproduced nor made available to third parties, and it may not be issued by the recipient or third parties in any other way. Infringements will be liable to damages and may result in criminal prosecution. Plettenberg Elektromotoren GmbH & Co. KG

Plettenberg Elektromotoren GmbH & Co. KG
 Rostocker Straße 30
 34225 Baunatal, Germany
 T: +49 (0) 56 01 97 96-0
 www.plettenbergmotors.com / sales@plettenbergmotors.com
 © 2026 Plettenberg Elektromotoren GmbH & Co. KG. All rights reserved.

