

## ORBIT Series



# ORBIT 15-37-B8 P20

Outrunner BLDC motor

### Overview

The ORBIT 15 is from our family of weight optimized outrunner BLDC motors and has been specifically designed for the most demanding applications, including uncrewed systems and aerospace.

### Features

- Ultra-light housing for weight sensitive applications
- Increased robustness through three bearing design, adding additional support to housing
- Useful for applications with high torque requirements
- Designed for use with sensorless ESCs

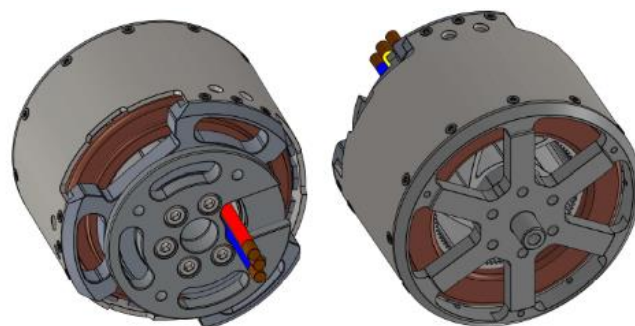

### Specifications

Peak output power	11	kW
Peak torque <sup>1</sup>	21	Nm
Max. speed	7,000	rpm
Voltage range	20-60	V
Speed constant (kV)	115	rpm/V
Diameter	103	mm
Length	84.5	mm
Weight	1,900	g
Phase cable length	100	mm
Cooling	Air cooled	
Ambient Temperature range	-20 to +60	°C
Number of poles	20	
Number of windings	8	
Peak thrust	44 kg with 36x12" prop	

### Complementary Products

- Sensorless third party ESCs (e.g. Hargrave/APD)

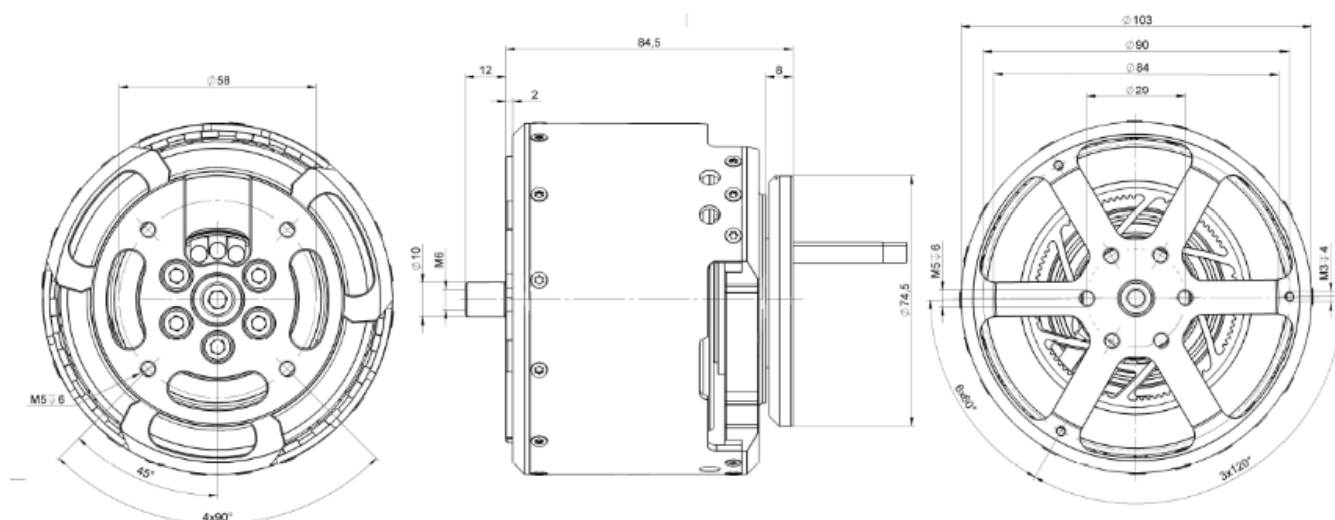

Plettenberg Elektromotoren GmbH & Co. KG  
Rostocker Straße 30  
34225 Baunatal, Germany  
T: +49 (0) 56 01 97 96-0  
www.plettenbergmotors.com / sales@plettenbergmotors.com  
© 2024 Plettenberg Elektromotoren GmbH & Co. KG. All rights reserved.

