

NOVA Series

NOVA 15-70-B6 P30 LW

Inrunner BLDC motor with closed housing



Overview

The NOVA 15 Light-Weight ("LW") is from our family of super rugged inrunner BLDC motors and has been specifically designed for the most demanding applications, including uncrewed systems and aerospace.

Features

- Super robust housing for mission critical applications in the harshest environments
- Best power-to-weight-to-robustness ratio in its class
- Position and temperature sensors included in standard
- Optimized shaft for Plettenberg propeller coupling



Specifications

Peak output power	20	kW
Peak torque ¹	55	Nm
Max. speed	8,000	rpm
Voltage range	40-160	V
Speed constant (kV)	49	rpm/V
Diameter	138	mm
Length	110	mm
Weight	3,600	g
Phase cable length	100	mm
Sensor cable length	400	mm
Protection class	IP54	
Cooling	Air cooled	
Ambient Temperature range	-20 to +60	°C
Max. temperature of stator (as measured by sensor)	+100	°C
Position sensor types	Hall effect sensor with UVW-commutation signals	
Temperature sensor	NTC 47 kΩ	
Number of poles	30	
Number of windings	6	
Peak thrust	90 kg with 48x16.4" prop	

Complementary Products

- Plettenberg propeller coupling: PC LW 6K 12mm
- Plettenberg ESCs: MST 80-240, MST 80-350, MST 140-200
- Plettenberg gold connectors: GC6-00 / GC6-90

Notes:

¹ With sensor-guided ESC

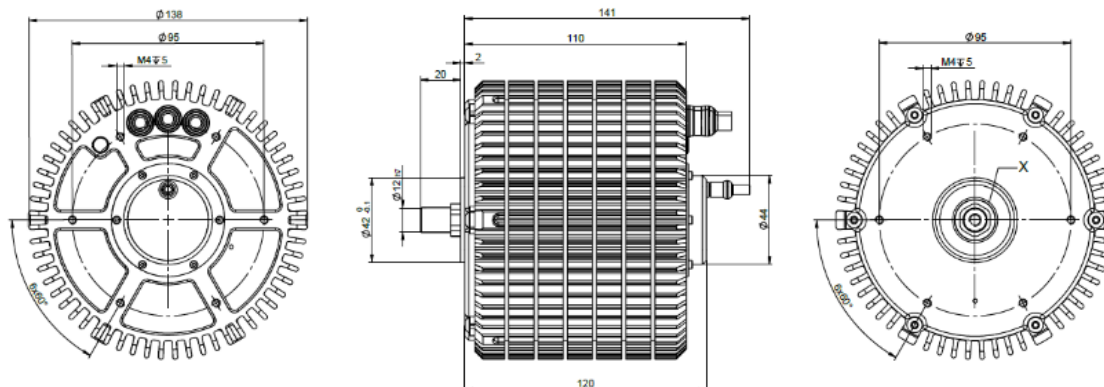

Plettenberg Elektromotoren GmbH & Co. KG

Rostocker Straße 30

34225 Baunatal, Germany

T: +49 (0) 56 01 97 96-0

www.plettenbergmotors.com / sales@plettenbergmotors.com

© 2024 Plettenberg Elektromotoren GmbH & Co. KG. All rights reserved.

